

NO	Item	Length (mm)	QTY
1	5050 Post	3200	4
2	1545 Rail	1664.7	4
3	Aluminum Insert	3344	8
4	1545 Rail	1664.7	12
5	15 Bracket		8
6	1545 Decorative End Caps		16
7	5050 Post Cap		4
8	5050 Post Trim		8
9	1545 Connector		8
10	1515 Picket	1656	24
11	1515 Connector		12
12	1515 Decorative End Caps		24
13	5050 Post Trim		4

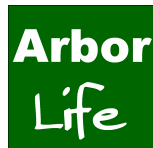

Design by		Product name	Arborlife Venetian	
Check by		Drawing NO		
Approve by		Revision	A/0	Sheet 1 Of 7
Complete date				

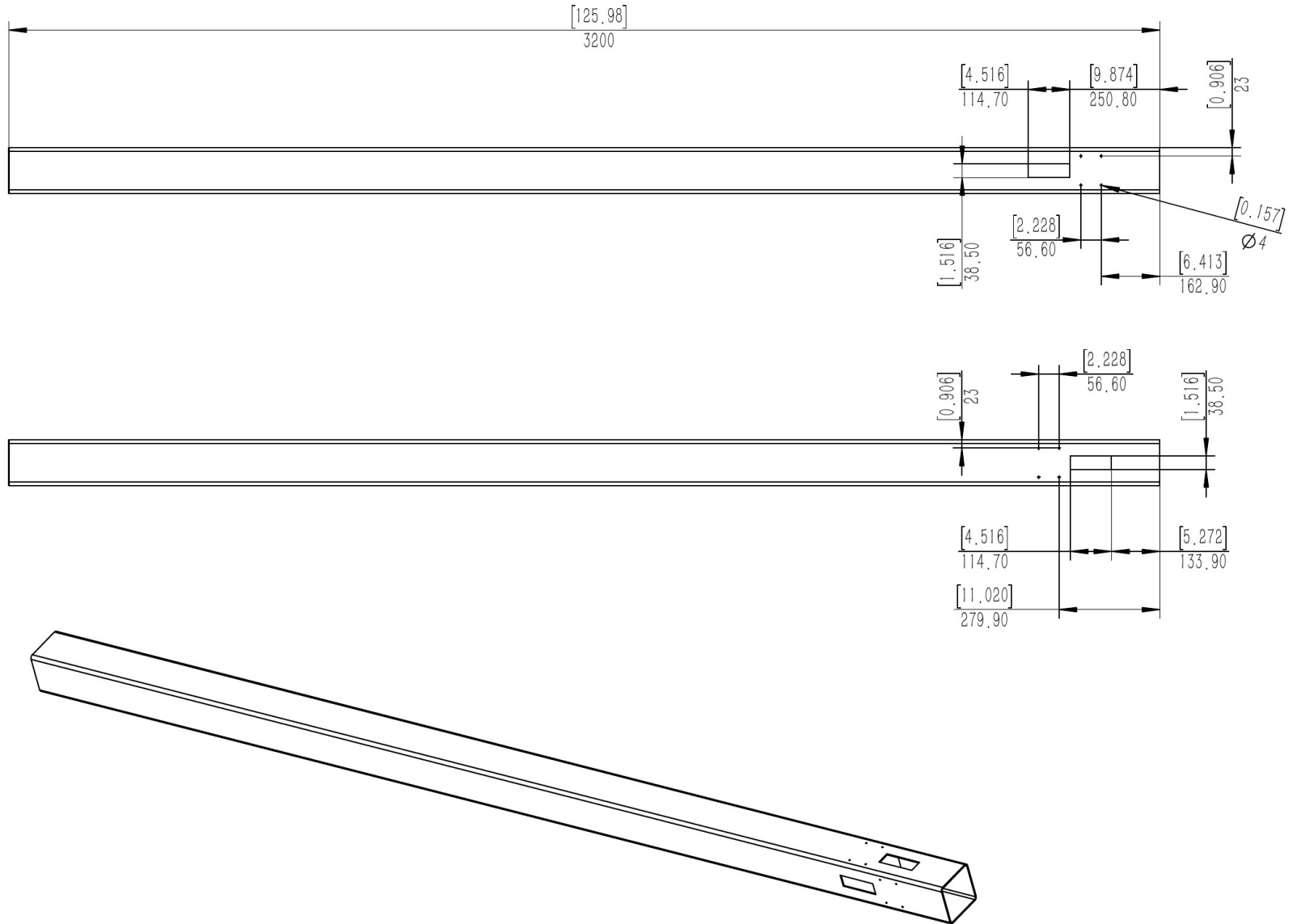

Design by		Product name	Arborlife Venetian	
Check by		Drawing NO	5050 Post	
Approve by		Revision	A/0	Sheet 2 Of 7
Complete date				

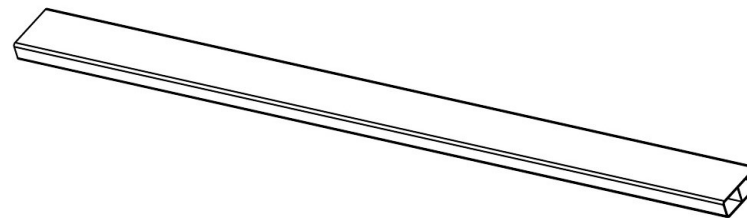
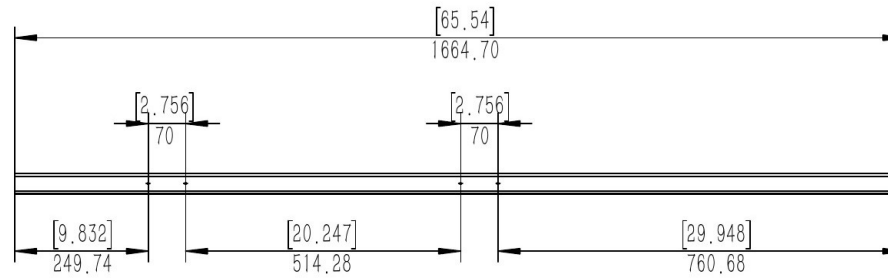

Design by		Product name	Arborlife Venetian	
Check by		Drawing NO	1545 Rail	
Approve by		Revision	A/0	Sheet 3 Of 7
Complete date				

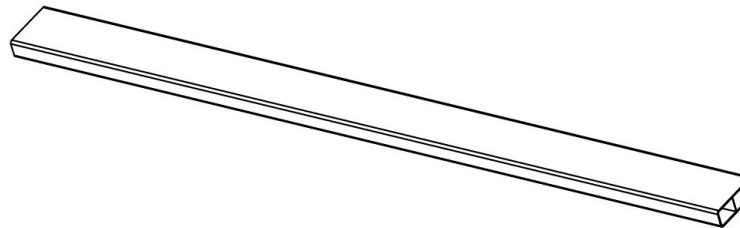
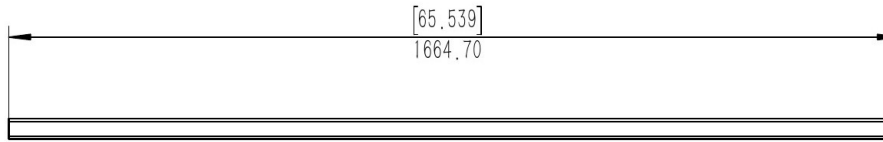

	Design by		Product name	Arborlife Venetian	
	Check by		Drawing NO	1545 Rail	
	Approve by		Revision	A/0	Sheet 4 Of 7
	Complete date				

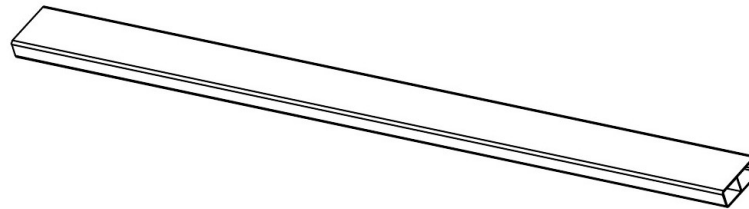
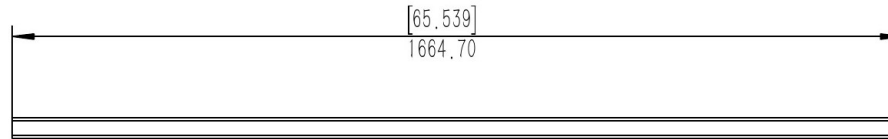

	Design by		Product name	Arborlife Venetian	
	Check by		Drawing NO	1545 Rafter	
	Approve by		Revision	A/0	Sheet 5 Of 7
	Complete date				

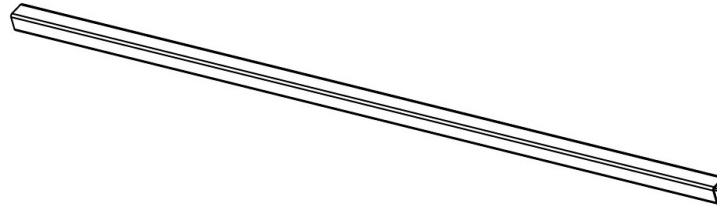
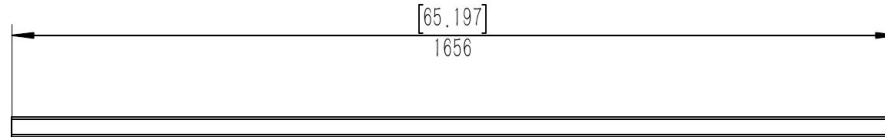

	Design by		Product name	Arborlife Venetian	
	Check by		Drawing NO	1515 Shade Slats	
	Approve by		Revision	A/0	Sheet 6 Of 7
	Complete date				

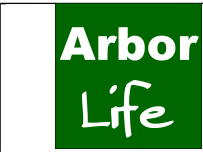
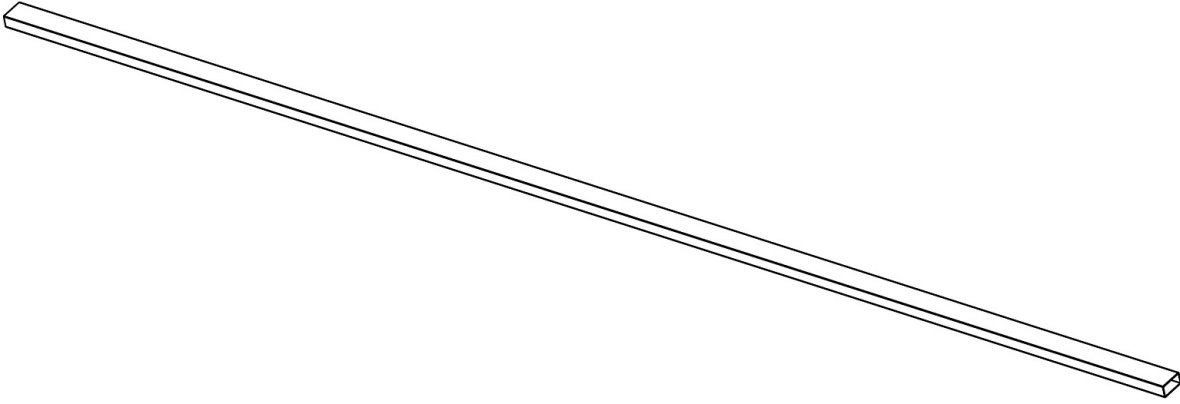
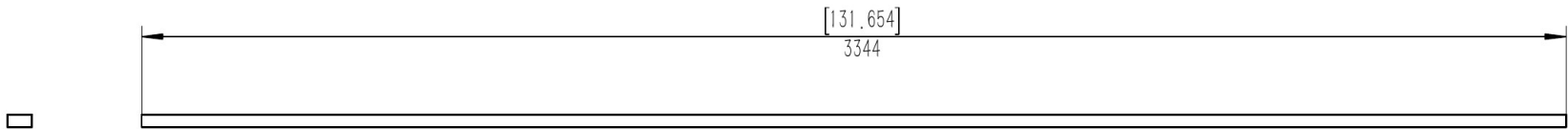

Design by	
Check by	
Approve by	
Complete date	

Product name	Arborlife Venetian
Drawing NO	Aluminum Insert
Revision	A/0

Sheet 7 Of 7	
--------------	--