

NO	Item	Length (mm)	Qty
1	2060 Bottom Rail	1949.2	1
2	2060 Middle Rail	1949.2	1
3	6078 TG	1219.2	12
4	2035 Top Rail	1949.2	1
5	1515 Picket-1	457.2	4
6	1515 Cap		24
7	1515 Picket-2	431.8	2
8	1515 Picket-3	460.4	18
9	TG U-channel		2
10	2060 Aluminum Insert	1949.2	1

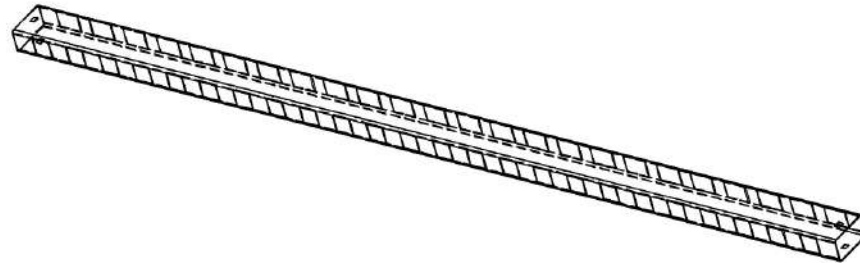

Design by		Product name	DPBSC74x78.74-6078-AF	
Check by		Drawing NO		
Approve by		Revision	A/0	Sheet 1 Of 8
Complete date				

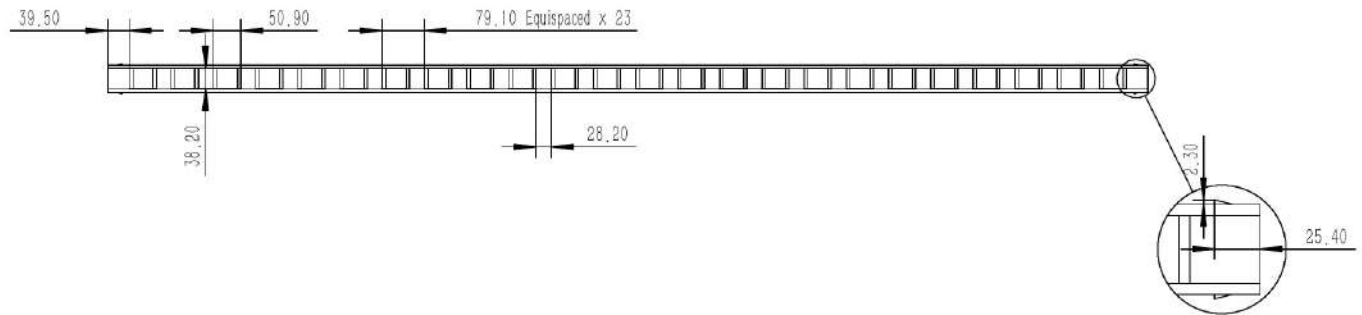
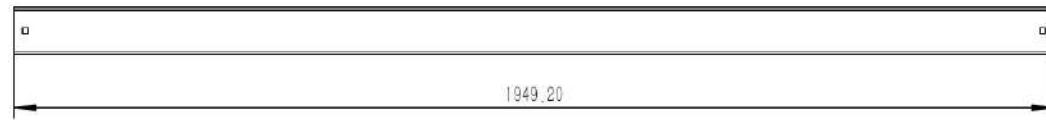
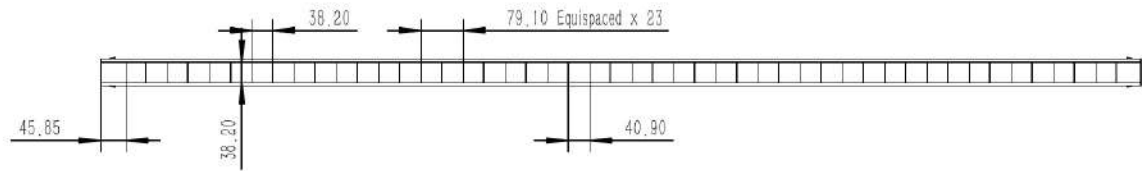

<b>Spread Eagles</b>	Design by		Product name	2035 Top Rail	
	Check by		Drawing NO		
	Approve by		Revision	A/0	Sheet 2 Of 8
	Complete date				

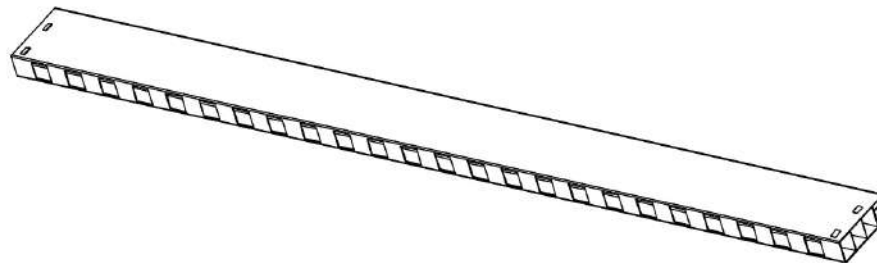
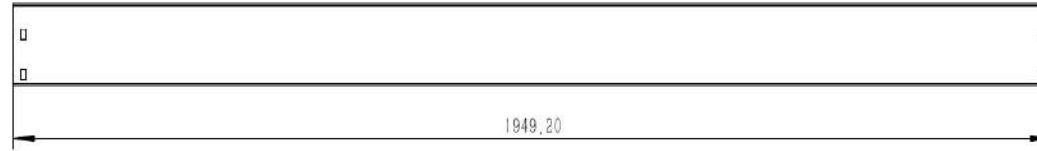
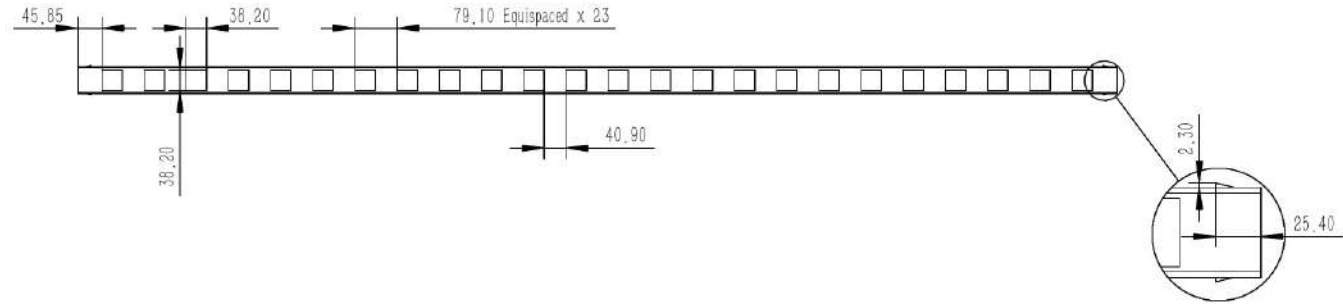

	Design by		Product name	2060 Middle Rail	
	Check by		Drawing NO		
	Approve by		Revision	A/0	Sheet 3 Of 8
	Complete date				

000E

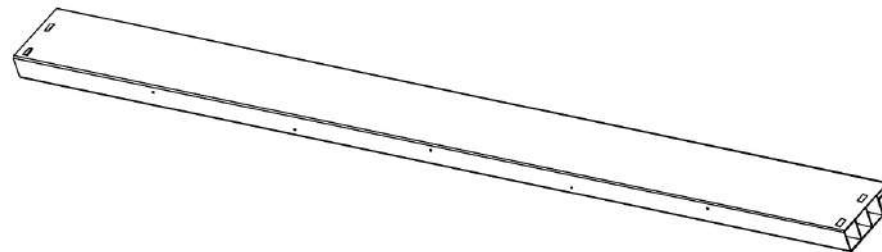
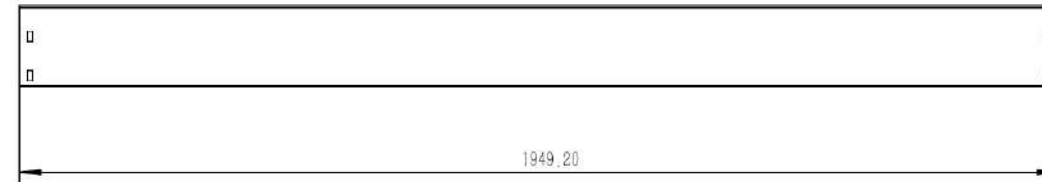
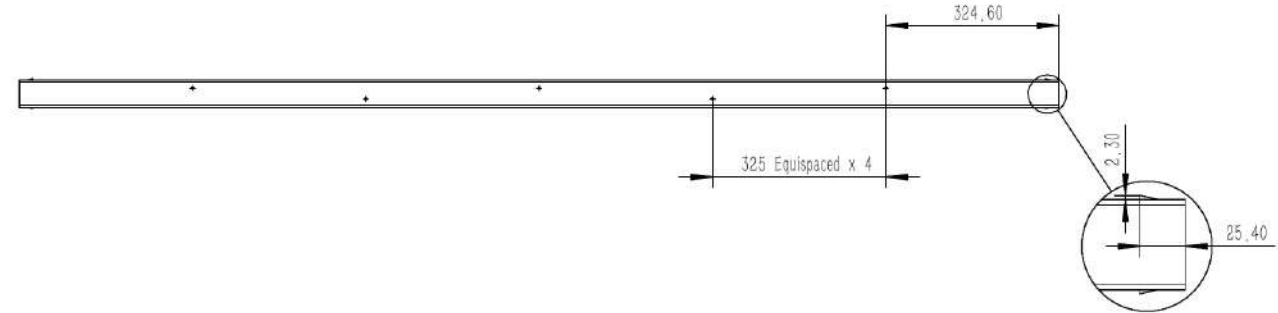

**Spread  
Eagles**

Design by		Product name	2060 Bottom Rail	
Check by		Drawing NO		
Approve by		Revision	A/0	Sheet 4 Of 8
Complete date				

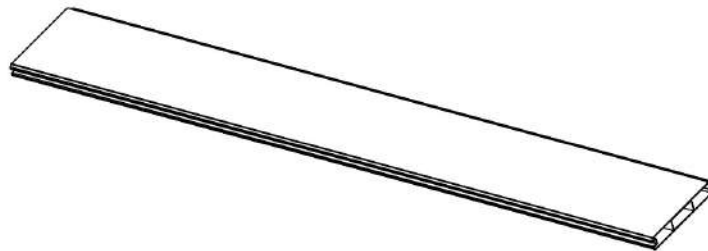
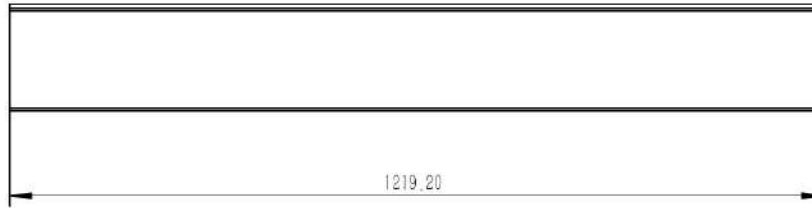

Design by		Product name	6078 TG	
Check by		Drawing NO		
Approve by		Revision	A/0	Sheet 5 Of 8
Complete date				

U

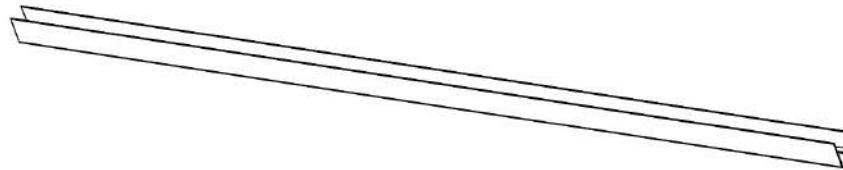

Design by		Product name	TG U-Channel	
Check by			Drawing NO	
Approve by		Revision		A/0
Complete date			Sheet 6	Of 8

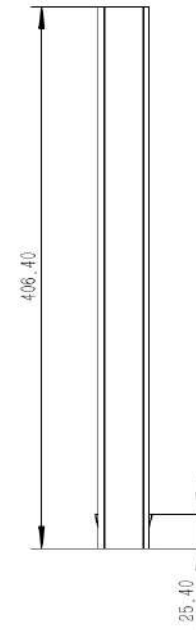
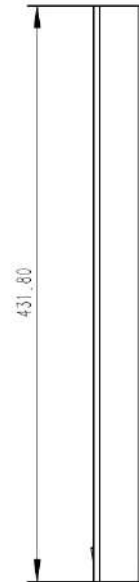

Design by		Product name	1515 Picket	
Check by		Drawing NO		
Approve by		Revision	A/0	Sheet 7 Of 8
Complete date				

H

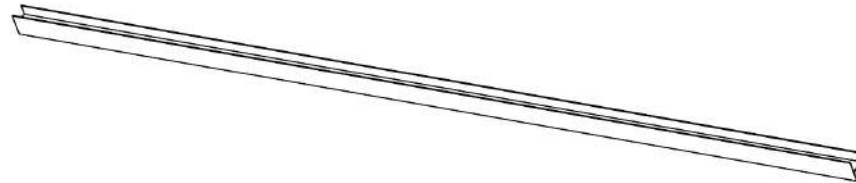
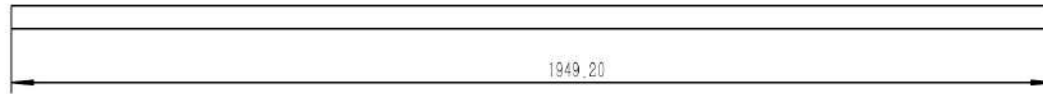

Design by		Product name	2060 Aluminum Insert	
Check by		Drawing NO		
Approve by		Revision	A/0	Sheet 8 Of 8
Complete date				