

NO	PN	Standard (mm)	Quantity (pcs)	Remarks
1	5050Post	2590.8	2	
2	2060Raill	2387.6	1	
3	U channel	1149	2	
4	2060Raill	2387.6	1	
5	6078 T&G	1219.2	15	
6	2035Raill	2387.6	1	
7	1515Picket	457.2	4	
8	1515Cap		29	
9	1515Picket	431.8	2	
10	1515Picket	460.4	23	

**Spread
Eagles**

Design by
Check by
Approve by
Complete date

Product name
Drawing NO
Revision

日本客户PVC栏杆

A/0

Sheet 1 Of 9

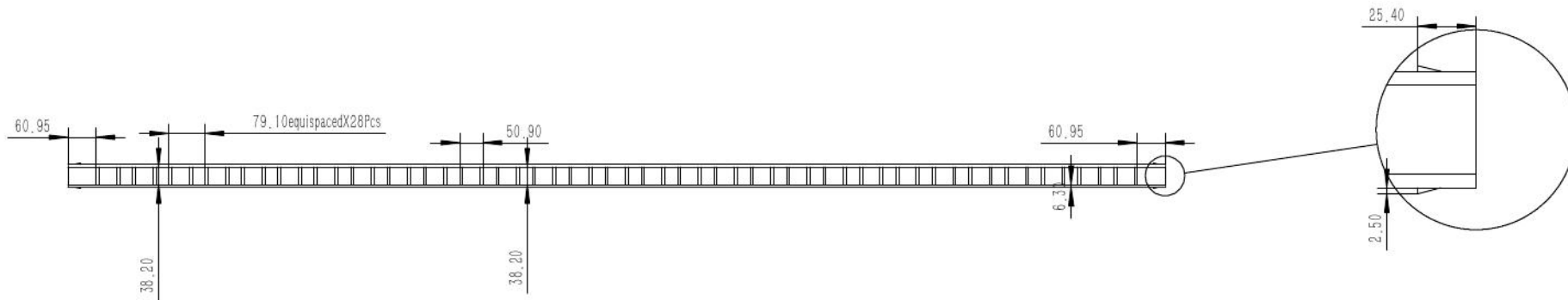
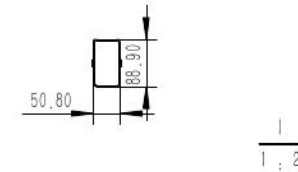
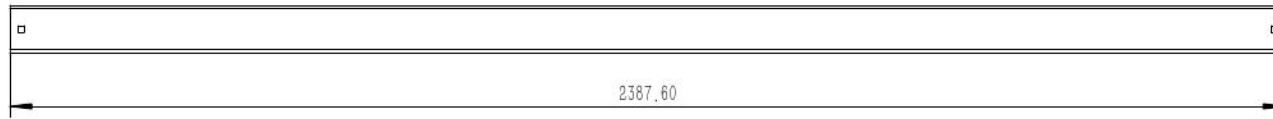
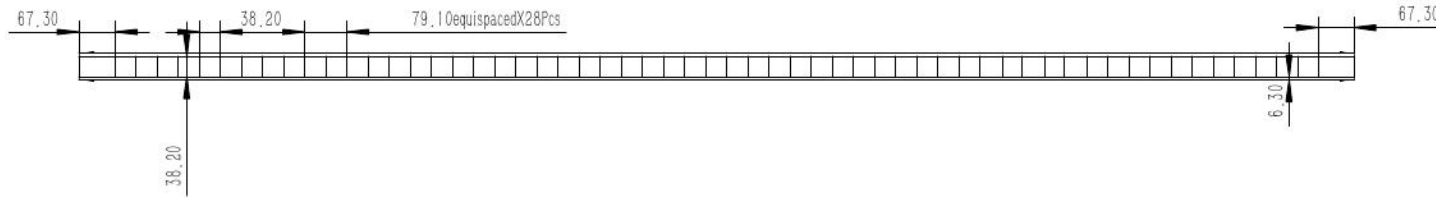
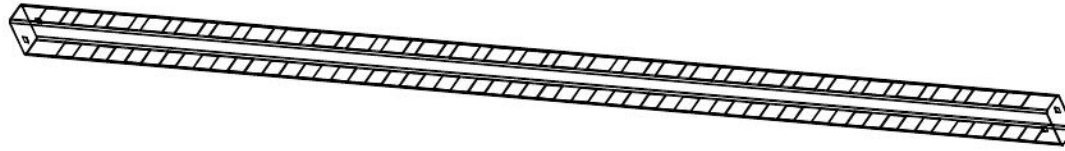

**Spread
Eagles**

Design by		Product name	日本客户PVC栏杆	
Check by		Drawing NO	2035Headrail	
Approve by		Revision	A/0	Sheet 2 Of 9
Complete date				

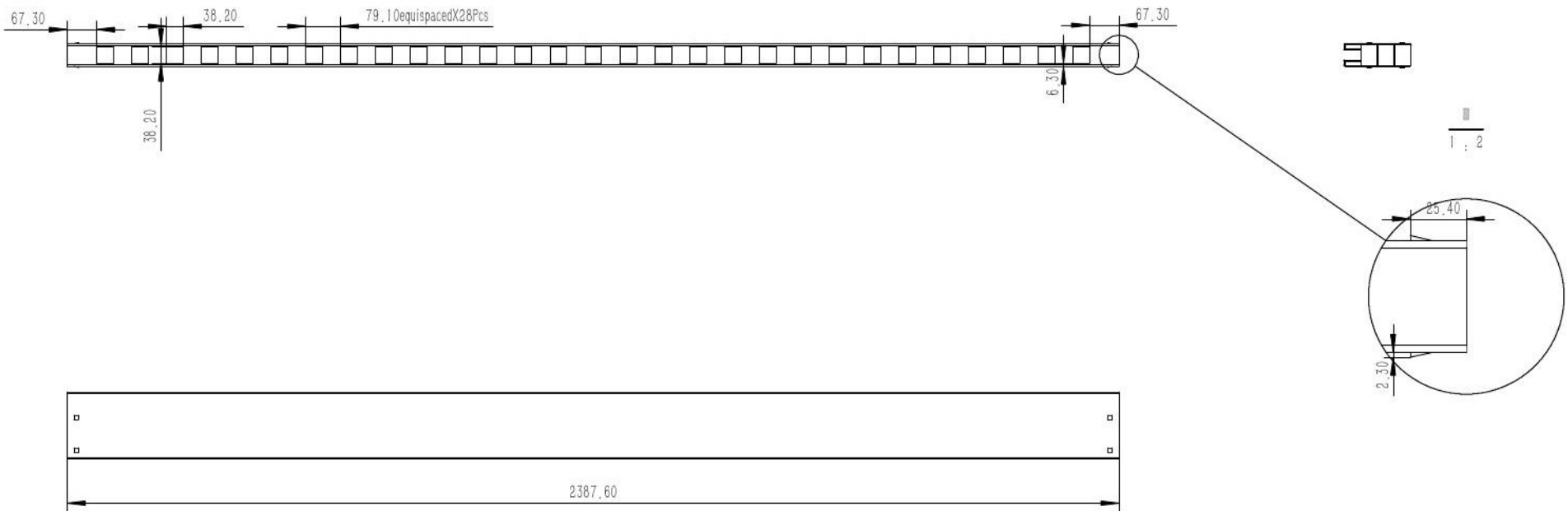
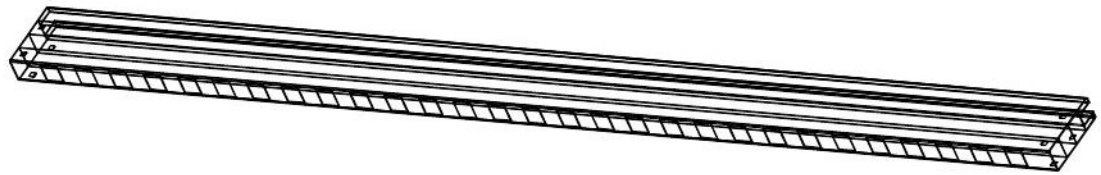

Design by		Product name	日本客户PVC栏杆	
Check by		Drawing NO	2060 The middle rung	
Approve by		Revision	A/0	Sheet 3 Of 9
Complete date				

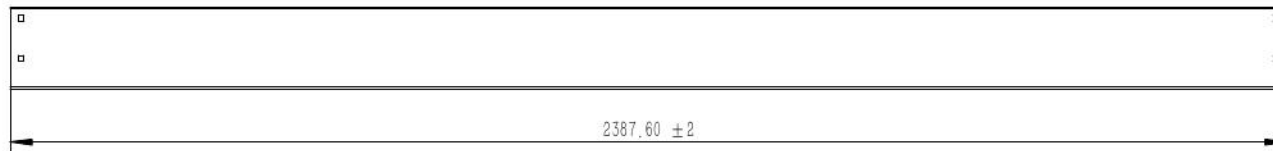
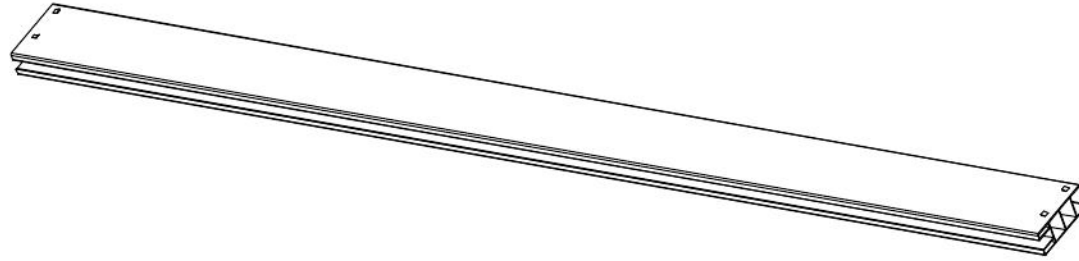

**Spread
Eagles**

Design by
Check by
Approve by
Complete date

Product name
Drawing NO
Revision

日本客户PVC栏杆

2060 The bottom rung

A/0

Sheet 4 Of 9

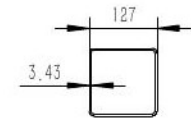
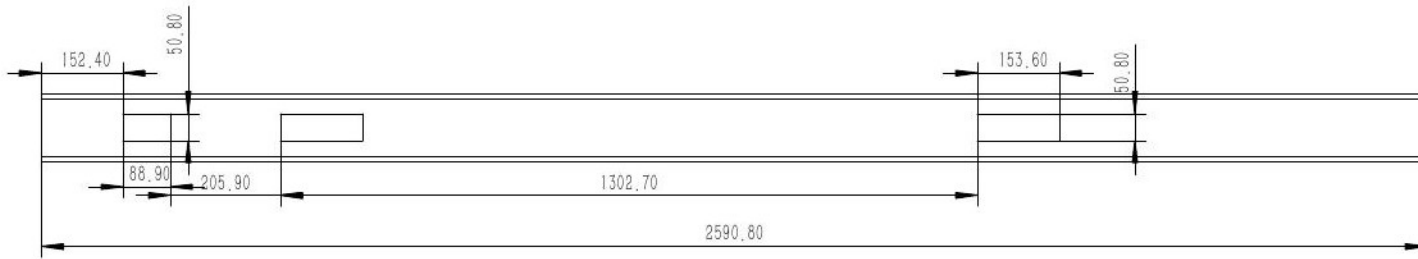
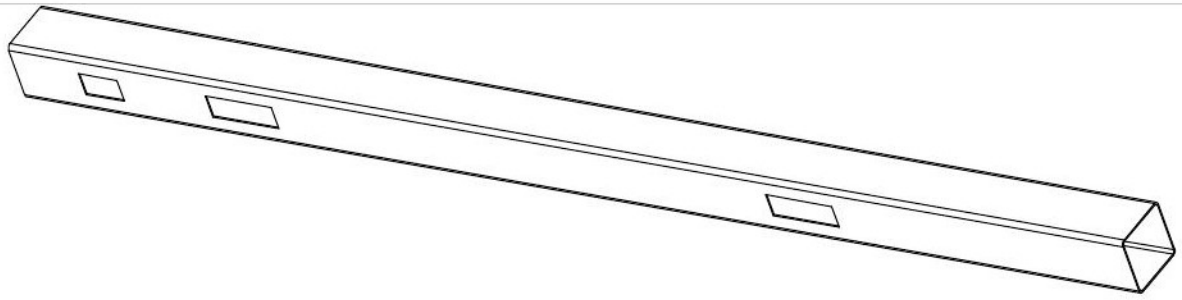

**Spread
Eagles**

Design by
Check by
Approve by
Complete date

Product name
Drawing NO
Revision

日本客户PVC栏杆

5050Post

A/0

Sheet 5 Of 9

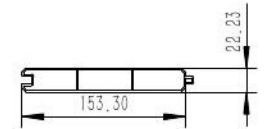
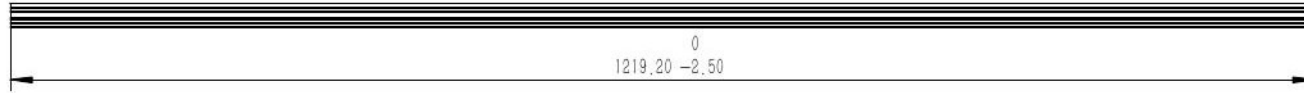
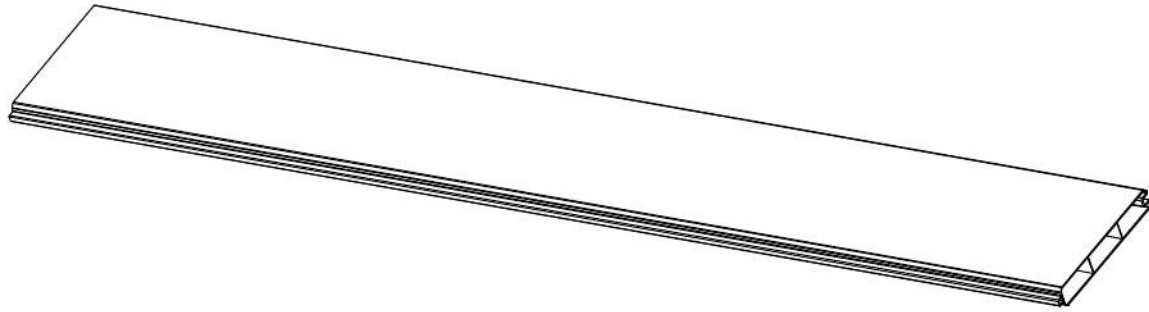

**Spread
Eagles**

Design by		Product name	日本客户PVC栏杆	
Check by		Drawing NO	6078 Shutter	
Approve by		Revision	A/0	Sheet 6 Of 9
Complete date				

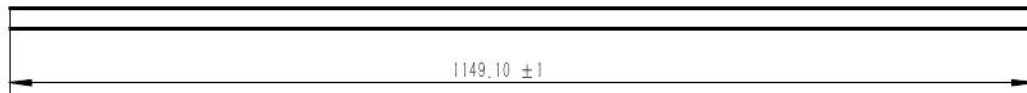
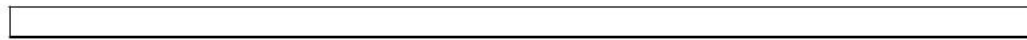
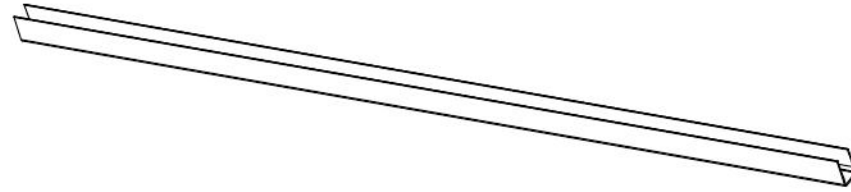

**Spread
Eagles**

Design by
Check by
Approve by
Complete date

Product name
Drawing NO
Revision

日本客户PVC栏杆

Door seal

A/0

Sheet 7 Of 9

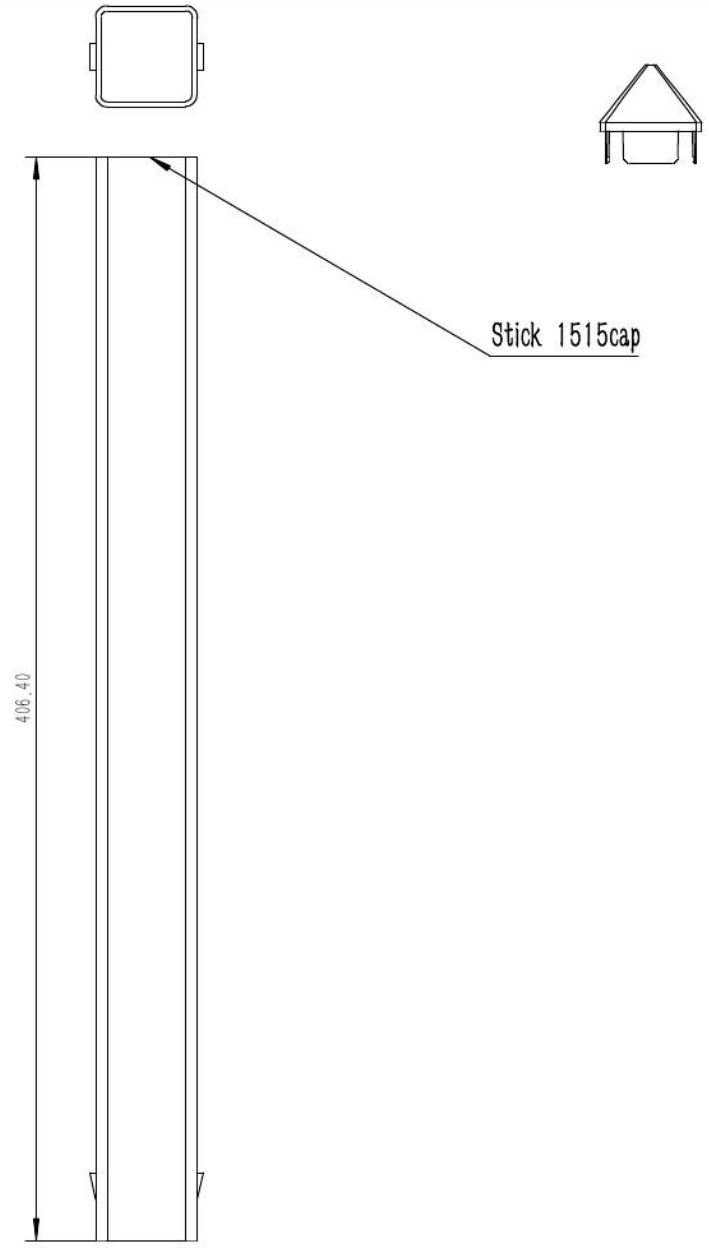
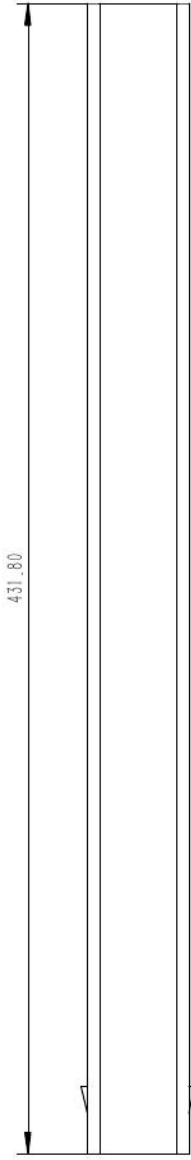
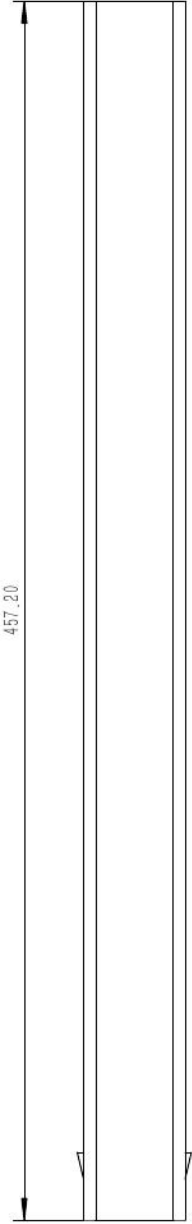

Design by		Product name	日本客户PVC栏杆	
Check by		Drawing NO	1515Picket	
Approve by		Revision	A/0	Sheet 8 Of 9
Complete date				

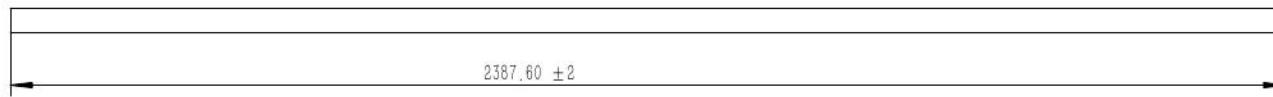
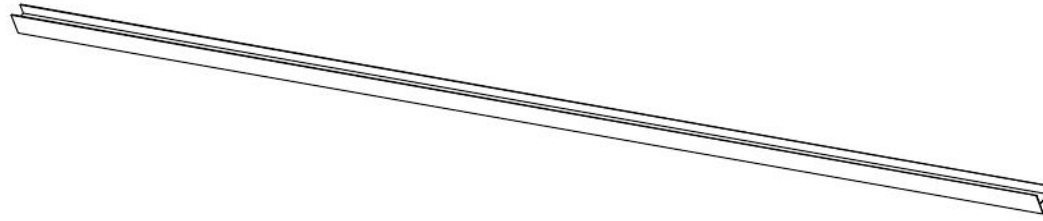

H

**Spread
Eagles**

Design by		Product name	日本客户PVC栏杆	
Check by		Drawing NO	Al pillared	
Approve by		Revision	A/0	Sheet 9 Of 9
Complete date				