

Design by
 Check by
 Approve by
 Complete date

Product name
 Drawing NO
 Revision

36RK8

A/0

Sheet 1 Of 7

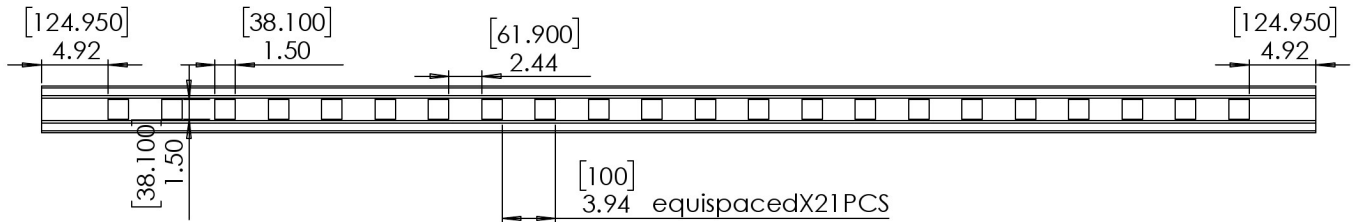
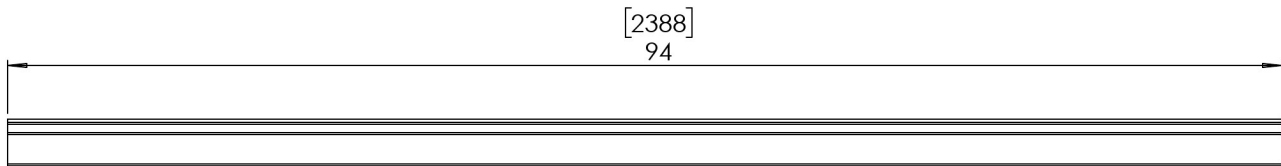
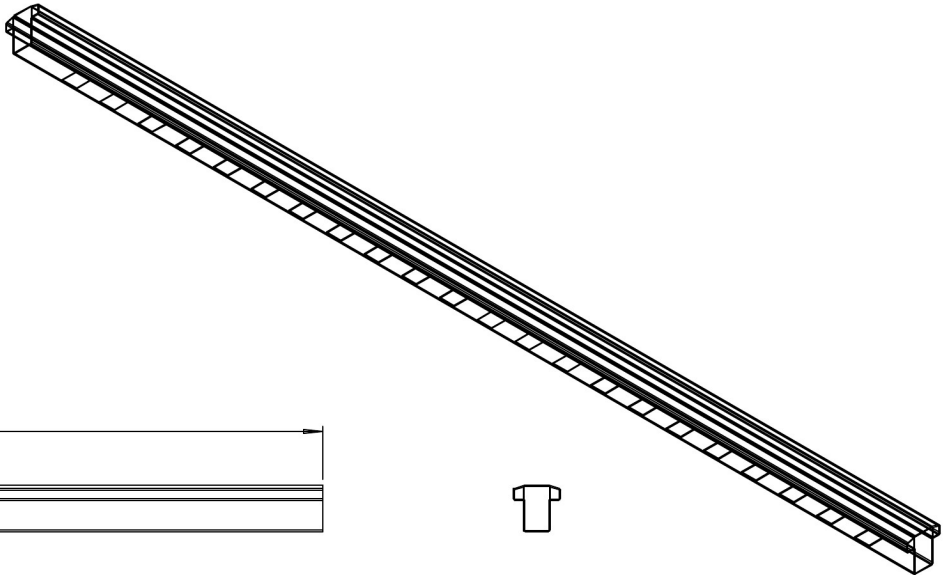

Design by
Check by
Approve by
Complete date

Product name

36RK8

Drawing NO

3535T Raill

Revision

A/0

Sheet 2 Of 7

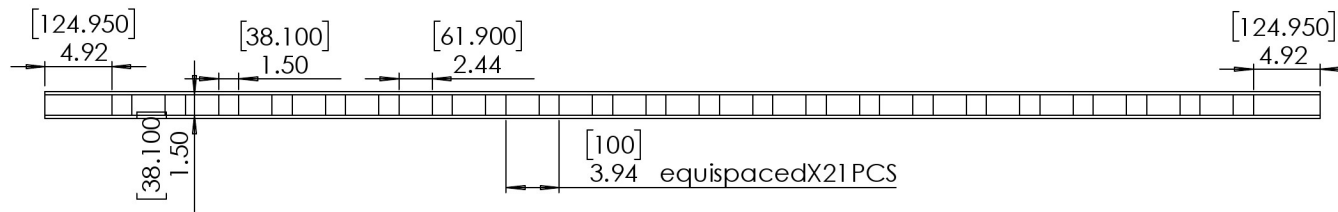
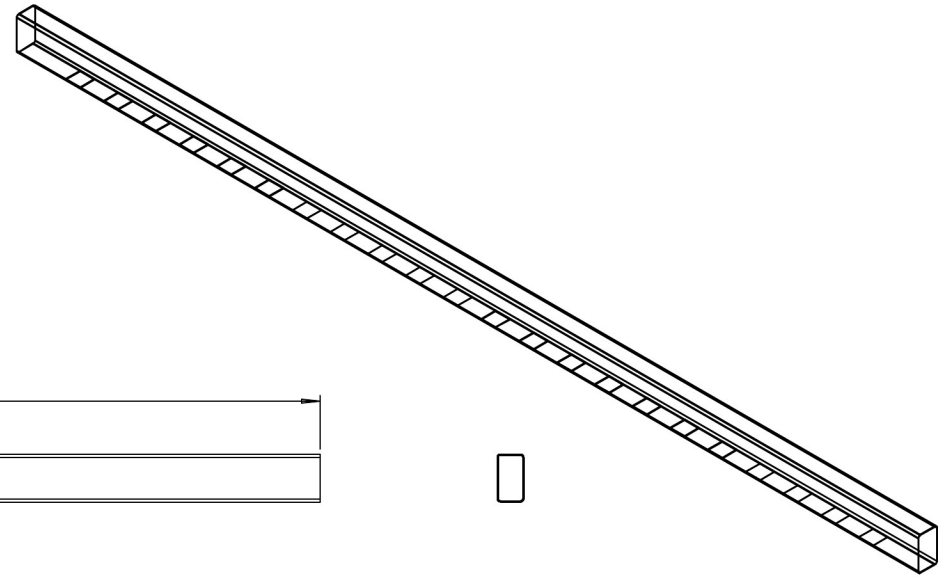
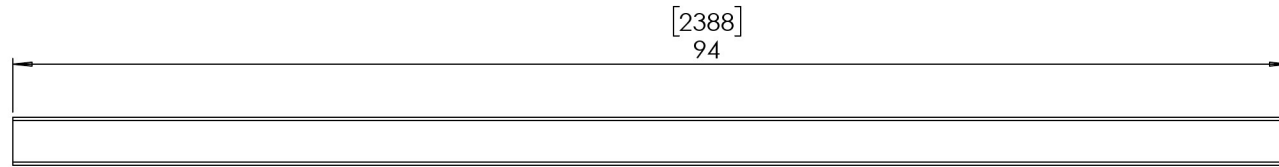

Design by
Check by
Approve by
Complete date

Product name
Drawing NO
Revision

36RK8

2035Raill

A/0

Sheet 3 Of 7

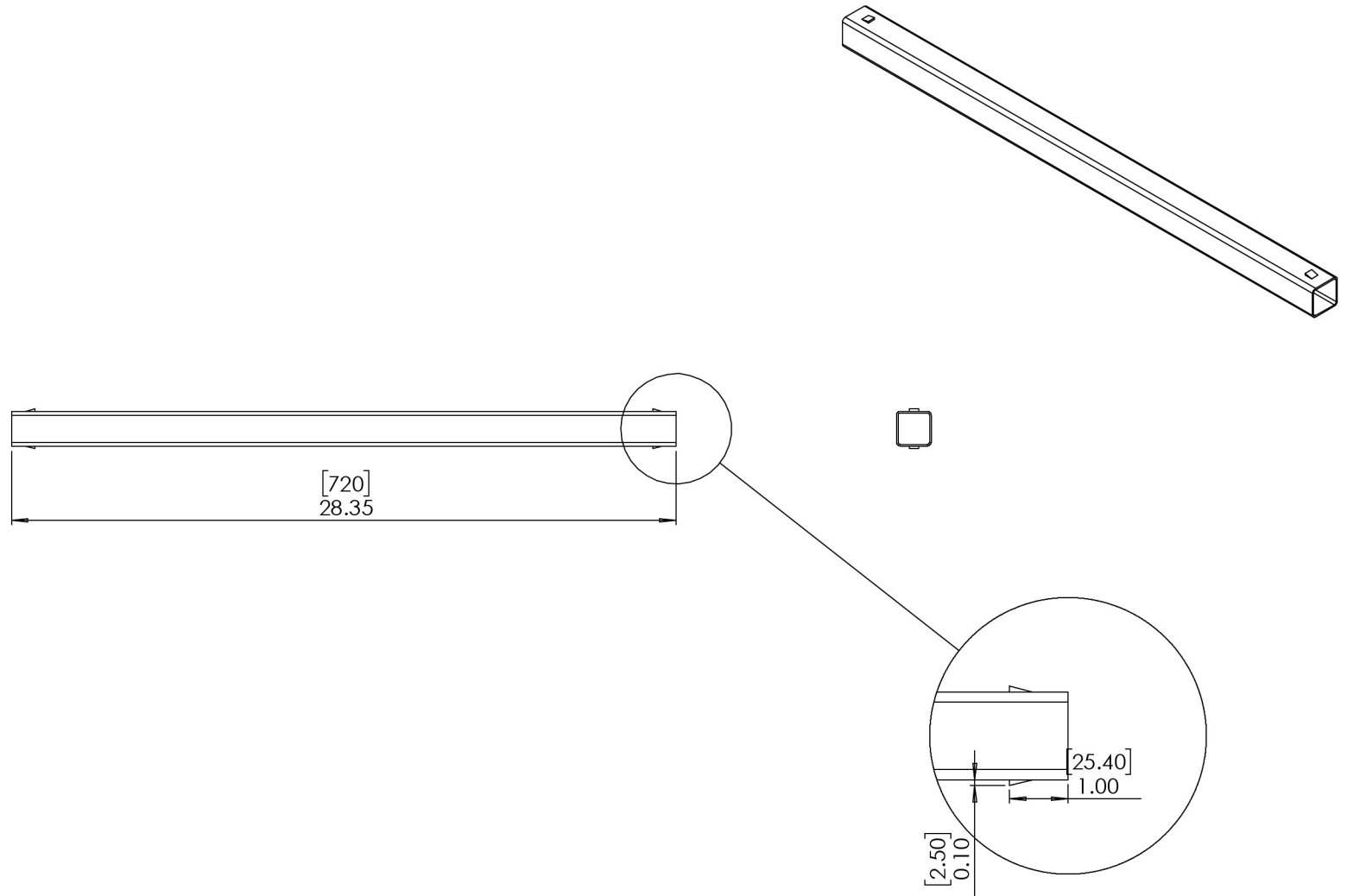

Design by
 Check by
 Approve by
 Complete date

Product name

36RK8

Drawing NO

1515Picket

Revision

A/0

Sheet 4 Of 7

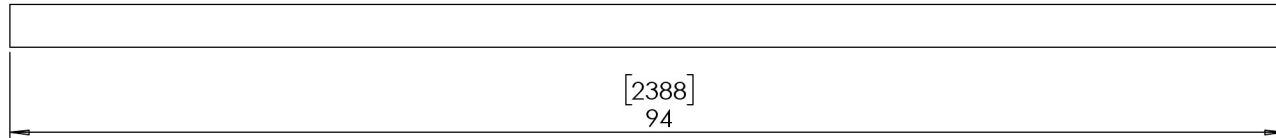
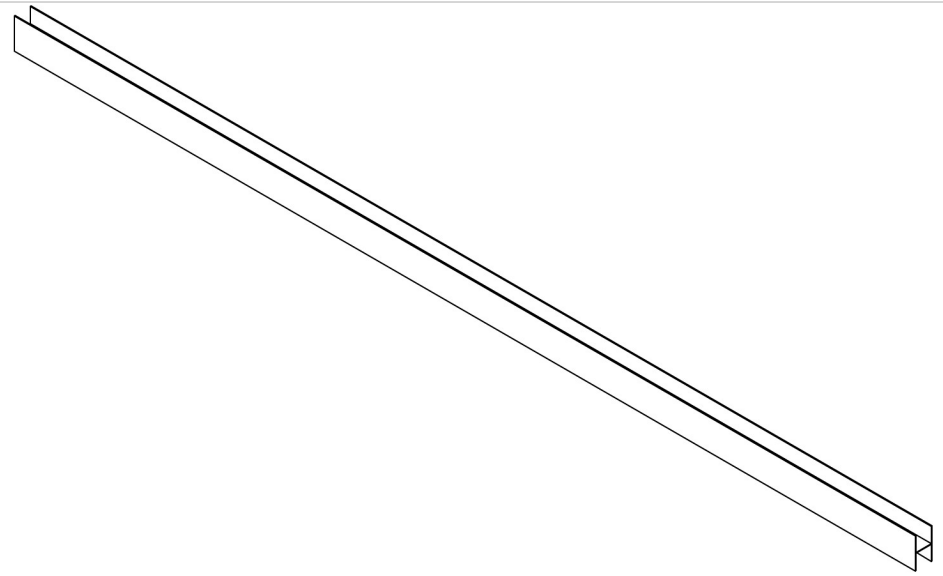

H

[2388]
94



Design by		Product name	36RK8	
Check by		Drawing NO	2035H Aluminum	
Approve by		Revision	A/0	Sheet 5 Of 7
Complete date				