

NO.	Item	Length	QTY
1	2060 TOP Rail	2387.60	1
2	2060 Bottom Rail	2387.60	1
3	AL Insert	2387	1
4	6078 TG	1547.26	15
5	TG U-Channle	1473.60	2
6	5050 Post	2590.80	2

**Spread
Eagles**

Design by
Check by
Approve by
Complete date

Product name
Drawing NO
Revision

DP70x94-6078-AF

A/O

Sheet 1 Of 7

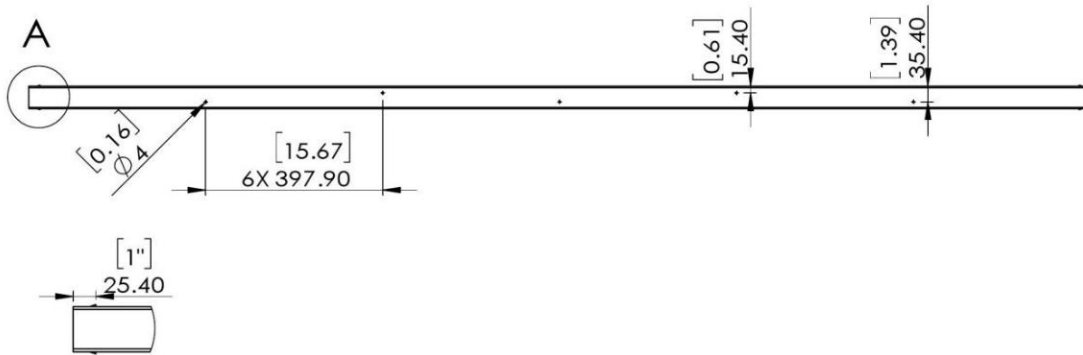
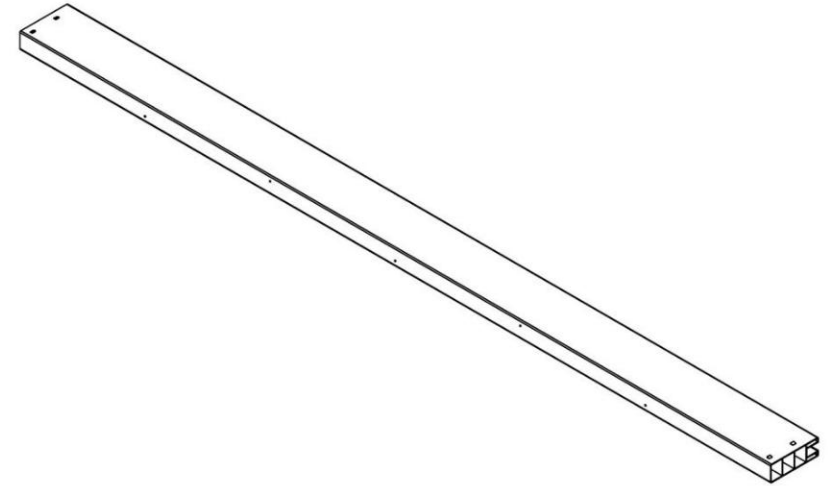
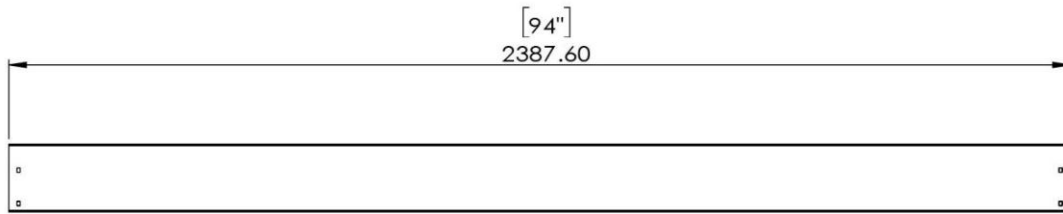

比例 1 : 6

**Spread
Eagles**

Design by
Check by
Approve by
Complete date

Product name
Drawing NO
Revision

2060 Bottom Rail

A/0

Sheet 2 Of 7

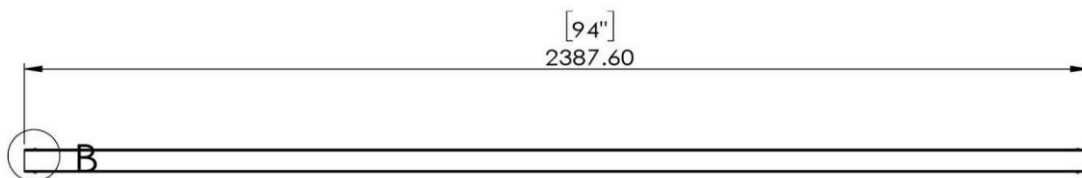
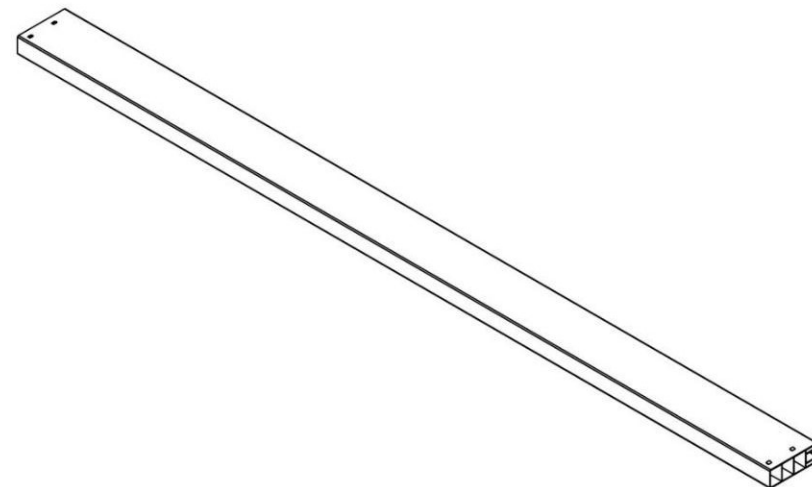

01E

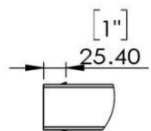

B

比例 1 : 6

**Spread
Eagles**

Design by
Check by
Approve by
Complete date

Product name
Drawing NO
Revision

2060 TOP Rail

A/0

Sheet 3 Of 7

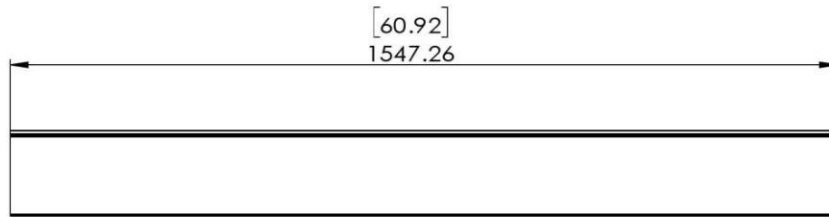
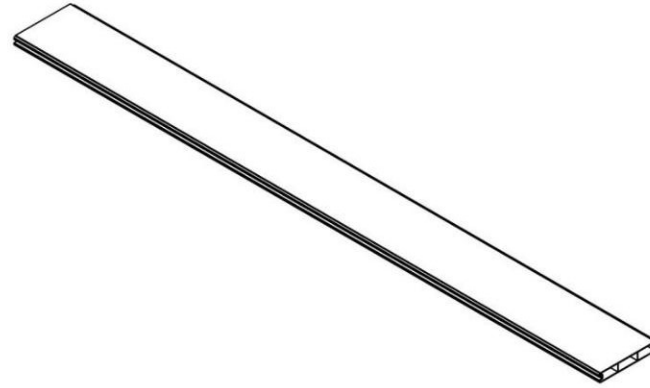

**Spread
Eagles**

Design by		Product name	6078 TG	
Check by		Drawing NO		
Approve by		Revision	A/0	Sheet 4 Of 7
Complete date				

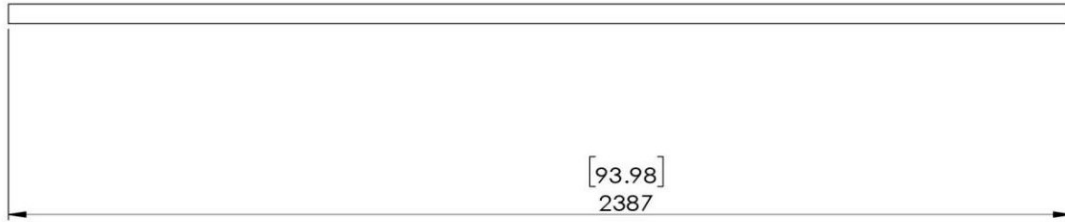
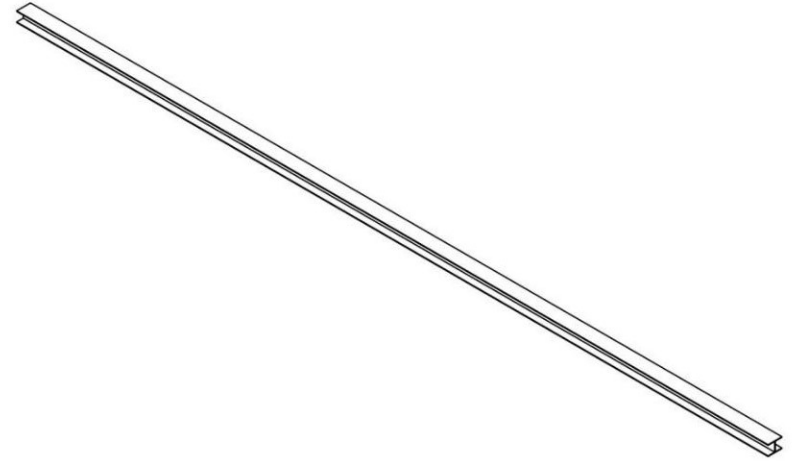

H



Design by		Product name	AL Insert	
Check by			Drawing NO	
Approve by		Revision		A/0
Complete date			Sheet 5	Of 7

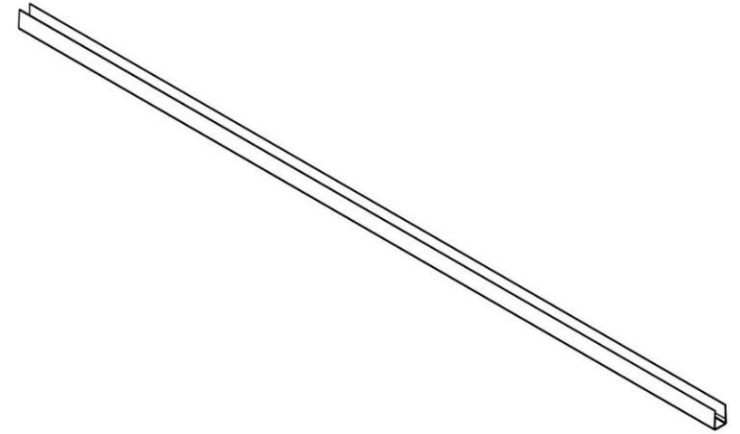
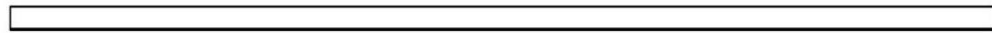
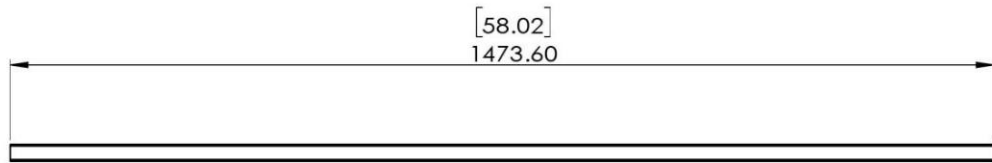

Spread Eagles	Design by		Product name	TG U-Channle	
	Check by		Drawing NO		
	Approve by		Revision	A/0	Sheet 6 Of 7
	Complete date				

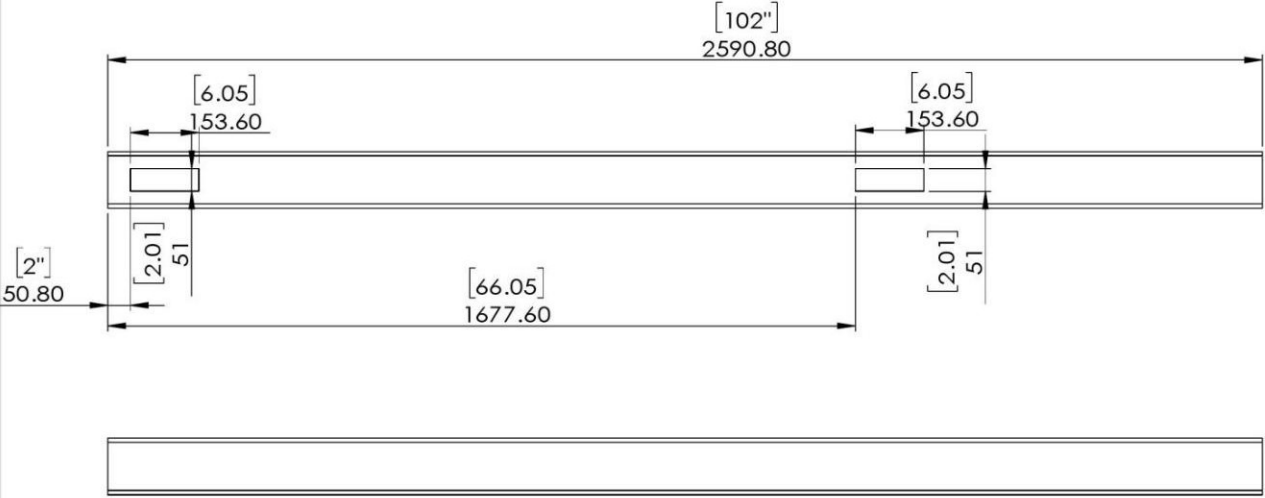
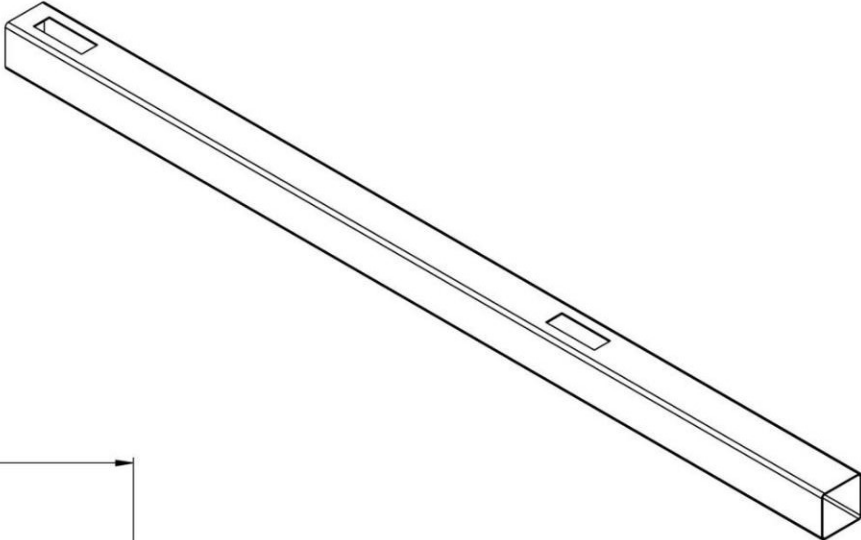

**Spread
Eagles**

Design by
Check by
Approve by
Complete date

Product name
Drawing NO
Revision

5050 Post